

No.	REVISIONS	DATE	DRAWN	APP.
①				
②				

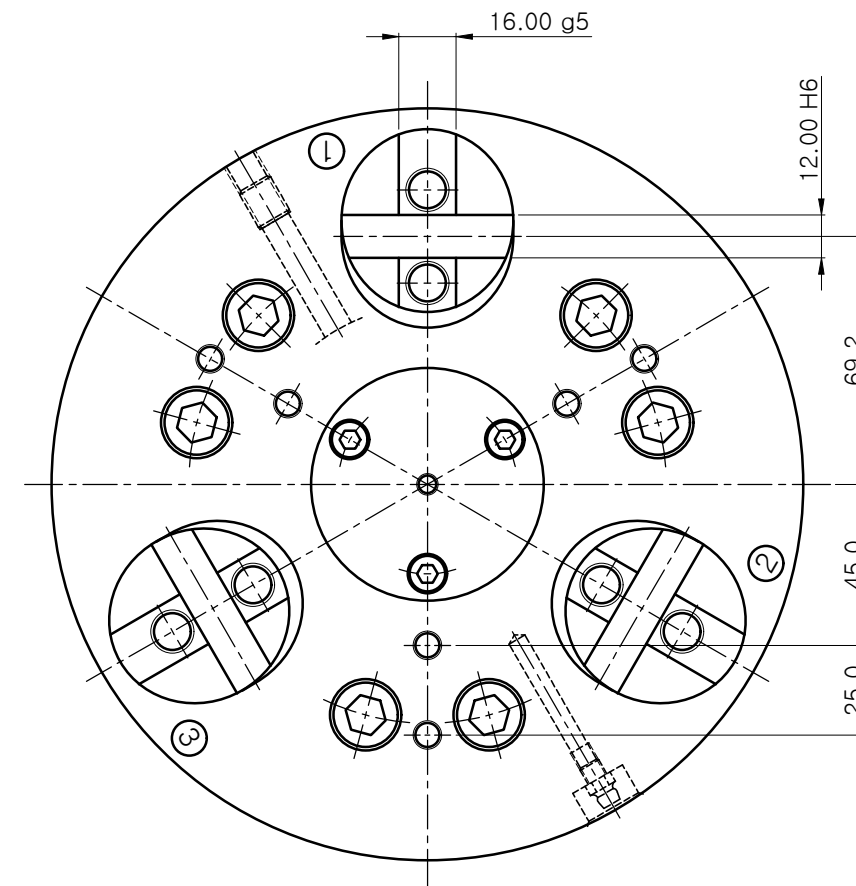
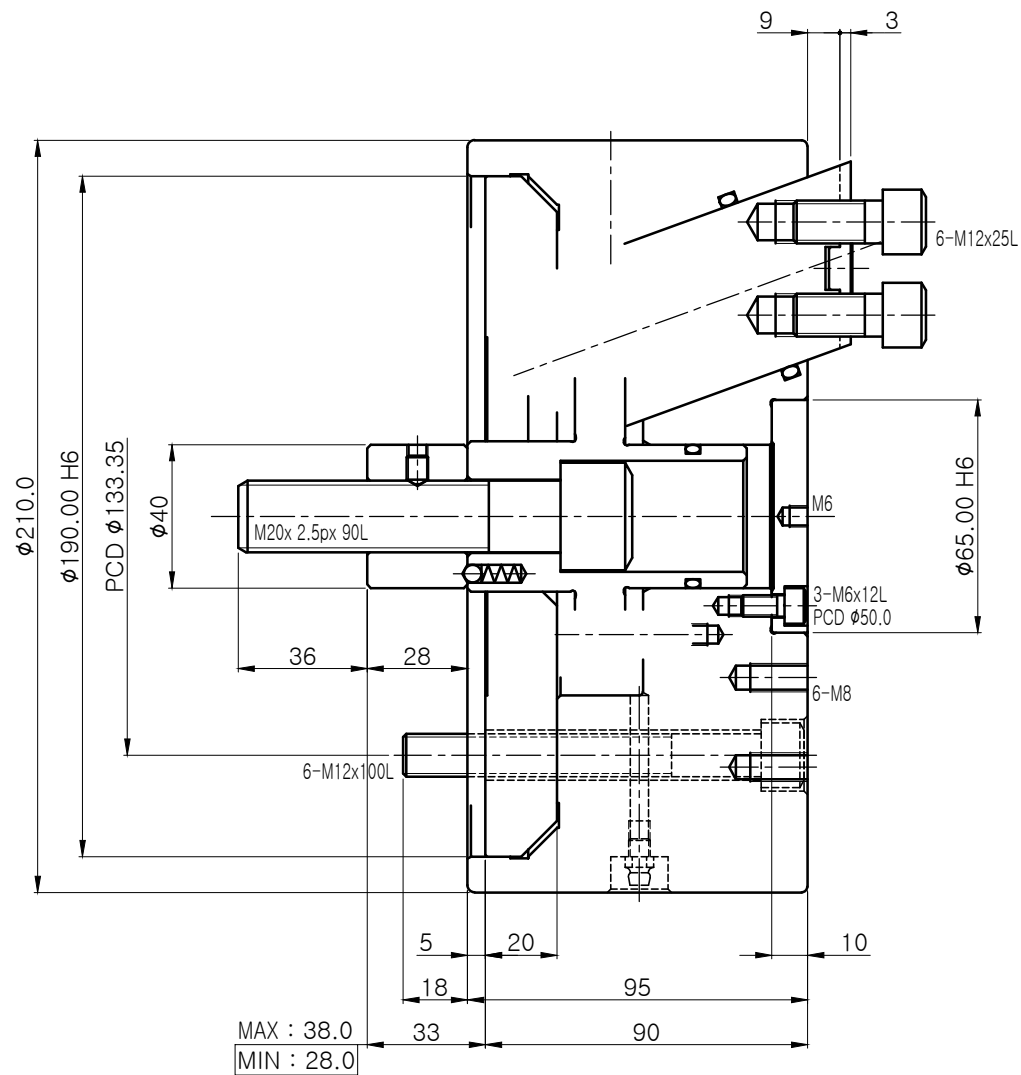

CHUCK SPEC.	
CHUCK SPEC.	DDL-08
PLUNGER STROKE	10 mm
JAW STROKE	7.2 mm
MAX. INPUT FORCE	2,500 kgf
CLAMPING FORCE	4,500 kgf
MAX. SPEED	3,000 rpm
MOMENT OF INERTIAL	0.66kgf.m ²
WEIGHT	27 kg

1	BLANK CHUCK	STD.	DDL-08	1SET	-
NO.	TITLE OF ITEM	MATERIAL	SIZE & SPEC.	Q'TY	NOTE
TITLE	DRAW DOWN CHUCK (DDL-08)		PART NAME	ASSEMBLY DRAWING	
DWG. NO.	DDL-08		AGENCY	-	
CODE NO.	-		USER	-	
			DATE	-	
SCALE	1 : 1	Approved	Checked	Designed	