

No.	REVISIONS	DATE	DRAWN	APP.
①				
②				

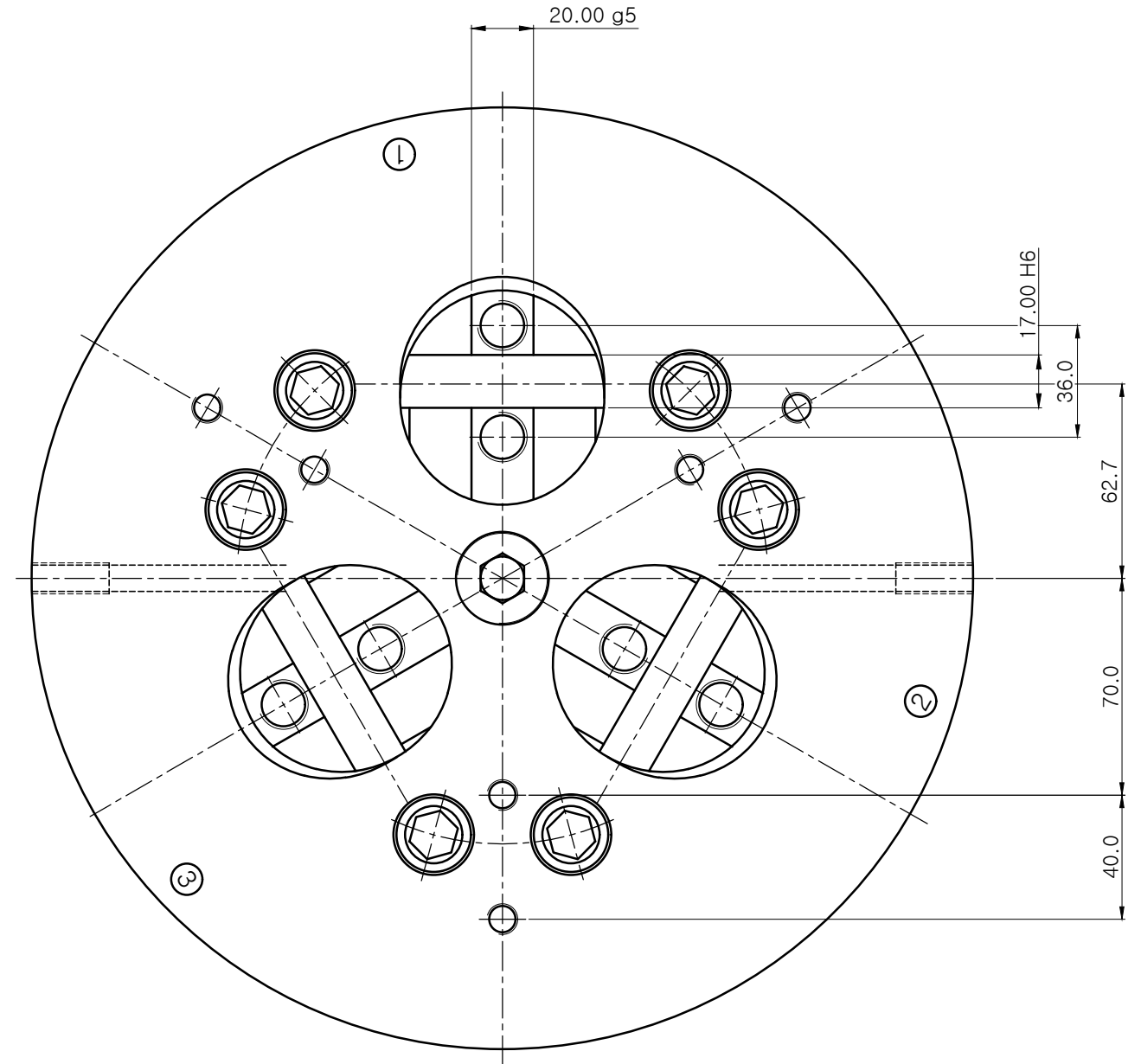
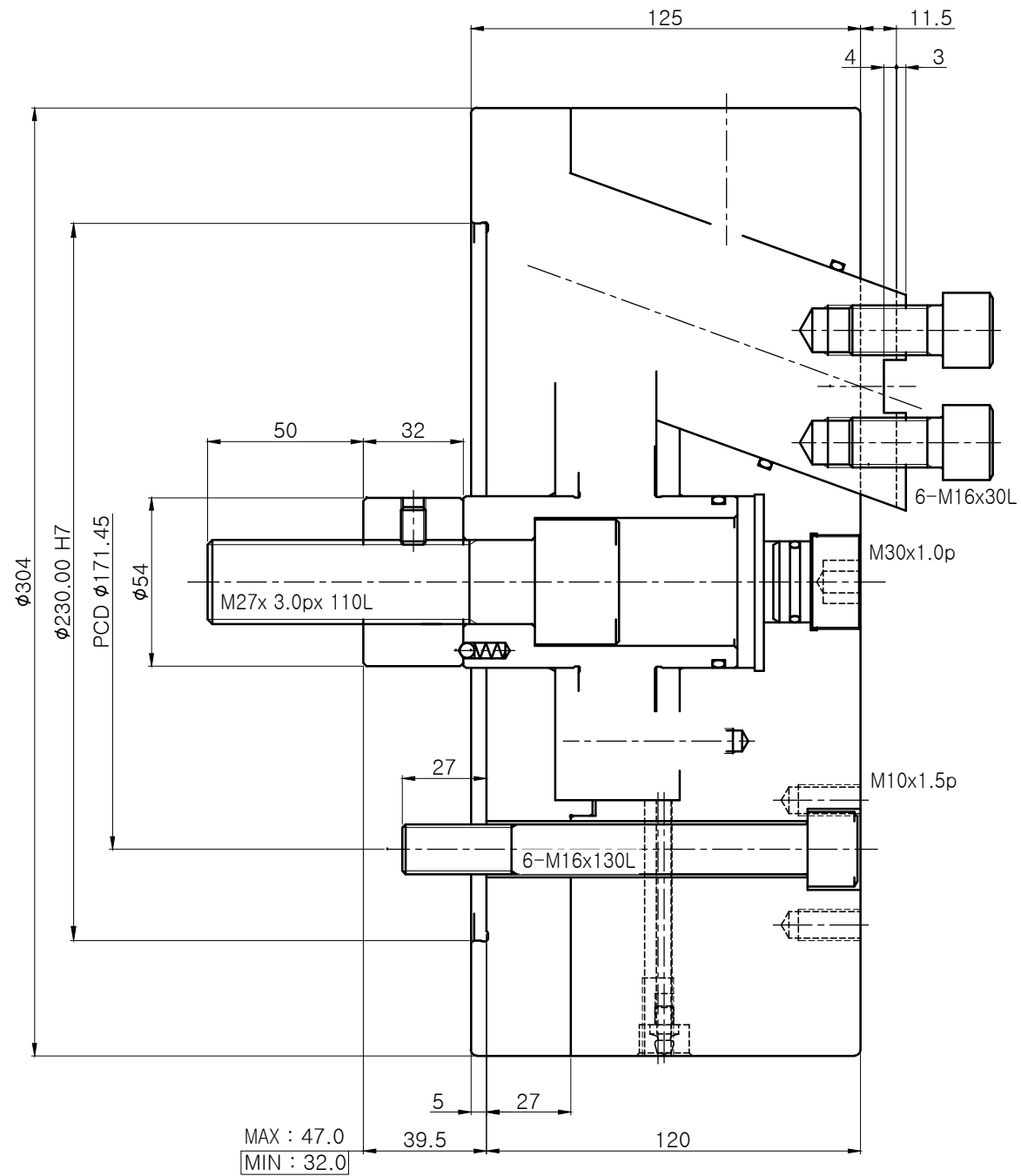

CHUCK SPEC.	
CHUCK SPEC.	DDO-12
PLUNGER STROKE	15 mm
JAW STROKE	10.8 mm
MAX. INPUT FORCE	4,500 kgf
CLAMPING FORCE	7,500 kgf
MAX. SPEED	3,500 rpm
MOMENT OF INERTIAL	2.9kgf.m ²
WEIGHT	68 kg

1	BLANK CHUCK	STD.	DDO-12	1SET	-
NO.	TITLE OF ITEM	MATERIAL	SIZE & SPEC.	Q'TY	NOTE
TITLE	DRAW DOWN CHUCK (DDO-12)		PART NAME	ASSEMBLY DRAWING	
DWG. NO.	DDO-12		AGENCY	-	
CODE NO.	-		USER	-	
			DATE	-	
SCALE	1 : 1	Approved	Checked	Designed	